

.7 hp Extension Cone or Plug Grinder Steel Housing

Air Tool Manual – Safety, Operation and Maintenance

SAVE THIS DOCUMENT, EDUCATE ALL PERSONNEL

Model:

53783 – 20,000 RPM, 3/8"-24 Spindle









FIND THE MOST CURRENT OFFERING OF SUPPORT DOCUMENTS AND ACCESSORIES AT WWW.DYNABRADE.COM

! WARNING

Read and understand this tool manual before operating your air tool. Follow all safety rules for the protection of operating personnel as well as adjacent areas. Always operate, inspect and maintain this tool in accordance with the American National Standards Institute (ANSI) Safety Code for Portable Air Tools – B186.1. For additional safety information, refer to Safety Requirements for the Use, Care and Protection of Abrasive Wheels – ANSI B7.1, Code of Federal Regulation – CUR 29 Part 1910, European Committee for Standards (EN) Hand Held Non-Electric Power Tools – Safety Requirements and applicable State and Local Regulations.

SAFETY LEGEND

	! WARNING Read and understand tool manual before work starts to reduce risk of injury to operator, visitors, and tool.	! WARNING Practice safety requirements. Work alert, have proper attire, and do not operate tools under the influence of alcohol or drugs.	
	! WARNING Eye protection must be worn at all times, eye protection to conform to ANSI Z87.1.	! WARNING Ear protection to be worn when exposure to sound, exceeds the limits of applicable Federal, State or local statutes, ordinances and/or regulations.	
	! WARNING Respiratory protection to be used when exposed to contaminant's that exceed the applicable threshold limit values required by law.	! WARNING Air line hazard, pressurized supply lines and flexible hoses can cause serious injury. Do not use damaged, frayed or deteriorated air hoses and fittings.	

! WARNING

Some dust created by sanding, grinding, drilling, and other construction activities contain chemicals known to cause cancer, birth defects or other reproductive harm. Some examples of these chemicals are:

- Lead from lead-based paints
- Crystalline silica from bricks and cement and other masonry products
- Arsenic and chromium from chemically treated lumber

Your risk from these exposures varies, depending on how often you do this type of work. To reduce your exposure to these chemicals: work in a well ventilated area, and work with approved safety equipment, such as those dust masks that are specially designed to filter out microscopic particles.

SAFETY INSTRUCTIONS

Carefully Read all instructions before operating or servicing any Dynabrade® Abrasive Power Tool. Products offered by Dynabrade are not to be modified, converted or otherwise altered from the original design without expressed written consent from Dynabrade, Inc.

Tool Intent: .7 hp Extension Cone or Plug Grinder is ideal for smoothing weld seams, cleaning casting and preparing surfaces for plating or painting. Use Type 16, 17, 18, 18R and 19 Cone or Plug wheels with a 3/8-24" female thread. DO NOT exceed 3in. dia. x 5in. long cone or plugs.

Do Not use tool for anything other than its intended applications.

This power tool is not intended for use in potentially explosive atmospheres and is not insulated against contact with electrical power.

Training: Proper care, maintenance, and storage of your air tools will maximize their performance.

- Employer's Responsibility – Provide .7 hp Extension Cone or Plug Grinder operators with safety instructions and training for safe use of tools and accessories.

(continued on next page)

SAFETY INSTRUCTIONS (Continued)

Accessory Selection:

- Abrasive/accessory RPM (speed) rating MUST be approved for AT LEAST the tool RPM rating.
- Before mounting an accessory, visually inspect for defects. Do not use defective accessories.
- Use only accessories of the correct thread size.
- Use only recommended accessories. Reference Dynabrade catalog and this tool manual.
- Follow tool specifications before choosing size and type of accessory.
- Only use recommended fittings and air line sizes. Air supply hoses and air hose accessories must have a minimum working pressure of 150 PSIG (10 Bars) or 150 percent of the maximum pressure produced in the system, whichever is higher. (See tool Machine Specifications table.)
- DO NOT USE cut-off wheels or router bits on this tool.

OPERATING INSTRUCTIONS

Warning: Always wear personal protective equipment. Operator of tool is responsible for following: accepted eye, face, respiratory, hearing and body protection.

Caution: Hand, wrist and arm injury may result from repetitive work, motion and overexposure to vibration.

- Keep hand and clothing away from working end of the air tool.
- Working end of tool has a potential of cutting and severing.

Warning: Be sure that any loose clothing, hair and all jewelry is properly restrained.

- Secure inlet bushing on air tool with a wrench before attempting to install the air fitting to avoid damaging housing assembly.
- BEFORE MOUNTING AN ACCESSORY, after all tool repairs and whenever a .7 hp Cone or Plug Grinder is issued for use, check tool RPM (speed) with tachometer with air pressure set at 90 PSIG while the tool is running. If tool is operating at a higher speed than the RPM marked on the tool housing, or operating improperly, the tool must be serviced and corrected before use.

Caution: Tool RPM must never exceed abrasive/accessory RPM rating. Check accessory manufacturer for details on maximum operating speed or special mounting instructions. Improper mounting of an accessory may cause excessive vibration levels or damage the accessory.

PROPER CONE or PLUG MOUNTING PROCEDURE

With Air Supply Disconnected from the Tool, Mount Recommended Accessory

- Check spindle thread and flange for wear or damage, replace any defective components.
- Inspect abrasive accessory for chipped, cracked or defective damage before mounting.
- Blotters must cover at least the adapter surface as shown.
- A blotter (compressible washer) shall always be used between the abrasive cone or plug surface and the adapter to ensure uniform distribution of pressure.
- New blotters shall be used each time a wheel is mounted unless blotters are affixed to the cone or plug by the manufacturer.
- Mount type 16, 17, 18, 18R and 19 Cone or Plug Wheels onto 3/8"-24 UNF-2A spindle thread. Less than 3in. dia. x less than 5in. length cone or plug wheels.
- Ensure the abrasive accessory is properly tightened before use.

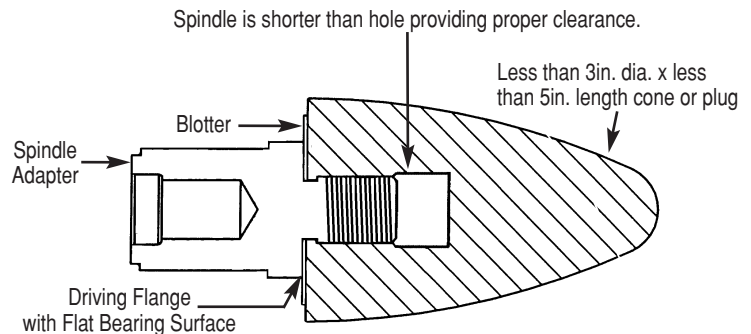

- Connect air tool to air supply. Be careful NOT to depress throttle lever in the process. **Do not expose air tool to inlet pressure above 90 PSIG or (6.2 Bars).**

Caution: After installing the accessory, before testing or use and/or after assembling tool, the .7 hp Cone or Plug Grinder must be started at a reduced speed to check for good balance. Gradually increase tool speed. DO NOT USE if tool vibration is excessive. Correct cause, and retest to insure safe operation. Test tool at its free speed (RPM) in a protected area for at least one minute before applying the tool to the work.

- Release throttle lever when air supply is interrupted.
- Make sure that work area is uncluttered, and visitors are at a safe range from the tools and debris.
- Air tools are not intended for use in explosive atmospheres and are not insulated for contact with electric power sources.
- Use a vise or clamping device to hold work piece firmly in place.
- Do not apply excessive force on tool or apply "rough" treatment to it.
- Always work with a firm footing, posture and proper lighting.
- Ensure that sparks and debris resulting from work does not create a hazard.
- Tool is rear exhaust which may contain lubricants, vane material, bearing grease, and other materials flushed thru the tool.

Warning: Grinding certain materials can create explosive dust. It is the employers responsibility to notify the user of acceptable dust levels.

- Grinding can cause sparks which can cause fires or explosions. It is the users responsibility to make sure the work area is free of flammable materials.
- Always use dust extraction or suppression systems and personal protective equipment which are suitable for the materials being processed.

Report to your supervisor any condition of the tool, accessories, or operation you consider unsafe.

Air System

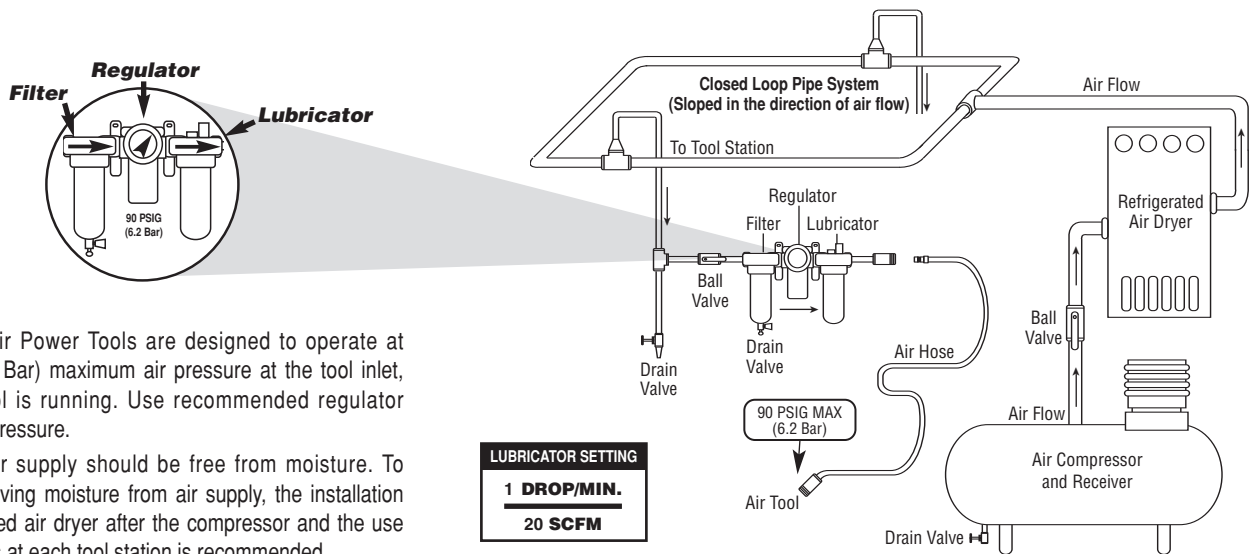

- Dynabrade Air Power Tools are designed to operate at 90 PSIG (6.2 Bar) maximum air pressure at the tool inlet, when the tool is running. Use recommended regulator to control air pressure.
- Ideally the air supply should be free from moisture. To facilitate removing moisture from air supply, the installation of a refrigerated air dryer after the compressor and the use of drain valves at each tool station is recommended.

Maintenance Instructions

Important: To keep tool safe a Preventative Maintenance Program is recommended whenever portable power tools are used. The program should include inspection of air supply lines, air line pressure, proper lubrication and repair of tools. Refer to ANSI B186.1 for additional maintenance information.

- Use only genuine Dynabrade replacement parts to ensure quality. To order replacement parts, specify **Model#**, **Serial#** and **RPM** of your air tool.
- It is strongly recommended that all Dynabrade rotary vane air tools be used with a Filter-Regulator-Lubricator to minimize the possibility of misuse due to unclean air, wet air or insufficient lubrication. Dynabrade recommends the following: **10681** Air Line Filter-Regulator-Lubricator — Provides accurate air pressure regulation, two-stage filtration of water contaminant's and micro-mist lubrication of pneumatic components. Delivers up to 55 SCFM/1,558 LPM @ 145 PSIG/9.7 Bar (Max. Air Temperature of 140°F/60°C) **Note:** Two (2) 3/8" NPT Reducer Bushings are included.
- Dynabrade recommends one drop of air lube per minute for each 20 SCFM (example: if the tool specification states 40 SCFM, set the drip rate on the filter-lubricator to 2 drops per minute). Dynabrade Air Lube (P/N **95842**: 1 pt 473 ml) is recommended.

Routine Preventative Maintenance:

- Check free speed of tool regularly using a tachometer without the abrasive accessory mounted. After all tool repairs and whenever a .7 hp Cone or Plug Grinder is issued for use, check tool RPM (speed) with tachometer with air pressure set at 90 PSIG while the tool is running. If tool is operating at a higher speed than the RPM marked on the tool housing, operating improperly or demonstrates unusual vibration, the tool must be serviced and corrected before use.
- Regularly inspect tool spindle and flange for wear or damage before use.
- Inspect accessories before mounting. Do not mount accessories that are damaged.
- Check accessory - speed rating. Rating on accessory must be greater than the tool speed marked on the housing.
- If accessory breakage occurs, investigate to determine the cause and correct before issuing tool for work.
- Mineral spirits are recommended when cleaning the tool and parts. Do not clean tool or parts with any solvents or oils containing acids, esters, ketones, chlorinated hydrocarbons or nitro carbons.
- **DO NOT** clean or maintain tools with chemicals that have a low flash point (example: WD-40®).
- A Motor Tune-Up Kit (P/N **98623**) is available which includes high wear and medium wear motor parts.
- Air tool markings must be kept legible at all times, if not, reorder housing and replace. User is responsible for maintaining specification information i.e.: Model #, S/N, and RPM. (See Assembly Breakdown)
- Blow air supply hose out prior to initial use.
- Visually inspect air hoses and fittings for frays, visible damage and signs of deterioration. Replace damaged or worn components.
- Refer to Dynabrade's Warning/Safety Operating Instructions Tag (Reorder No. **95903**) for safety information.

After maintenance is performed on tool, add a few drops of Dynabrade Air Lube (P/N **95842**) to the air line and start the tool a few times to lubricate air motor. Check for tool vibration before mounting abrasive wheel accessory.

Handling and Storage:

- Use of tool rests, hangers and/or balancers is recommended.
- Protect tool inlet from debris (see Notice on Page 7).
- **DO NOT** carry tool by air hose or near the tool throttle lever.
- Protect tool from exposure to water, solvents, high humidity, freezing temperature and extreme temperature changes.
- **DO NOT USE** accessories that have been dropped or show signs of cracks, nicks or other defects.
- Store accessories in protective racks or compartments to prevent damage.
- Store and Handle abrasive accessories according to the manufacturer.

.7 hp Extension Cone or Plug Grinder

Complete Assembly – All Models

Model:
53783 - Cone or Plug Grinder

Index Key

No.	Part #	Description
1	53610	Adapter
2	96524	Retaining Ring
3	51956	Felt Seal
4	01007	Bearing (3)
5	53690	Grip
6	51952	Handle
7	51955	Spindle
8	54520	Bearing
9	51969	Coupling Nut (2)
10	51982	Spacer
11	96498	Spring
12	50902	Coupler
13	02376	Adapter Extension
14	04069	Retaining Plate
15	02377	Adapter
16	01121	Shim (3/pkg.)
17	02375	Front Plate
18	50767	Pin (3)
19	01010	Spacer
20	01185	Vane (4/pkg.)
21	55021	Rotor
22	01028	Cylinder
23	01721	Rear Plate
24	02649	Bearing
25	01017	Pin
26	01089	Safety Lever
27	Housing (Includes Bushing 01004)	
	02383	Housing - 53783
28	01020	O-Ring
29	01021	Valve Stem
30	01022	spring
31	01023	Speed Regulator
32	01024	O-Ring
33	95288	O-Ring
34	01026	Regulator Plug
35	95711	Snap Ring
36	96065	O-Ring
37	01486	Felt Silencer (4)
38	01446	Air Deflector
39	95620	Retaining Ring
40	01578	Inlet Adapter
41	94535	Muffler Assembly
42	02347	Insulation Sleeve

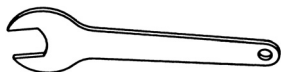
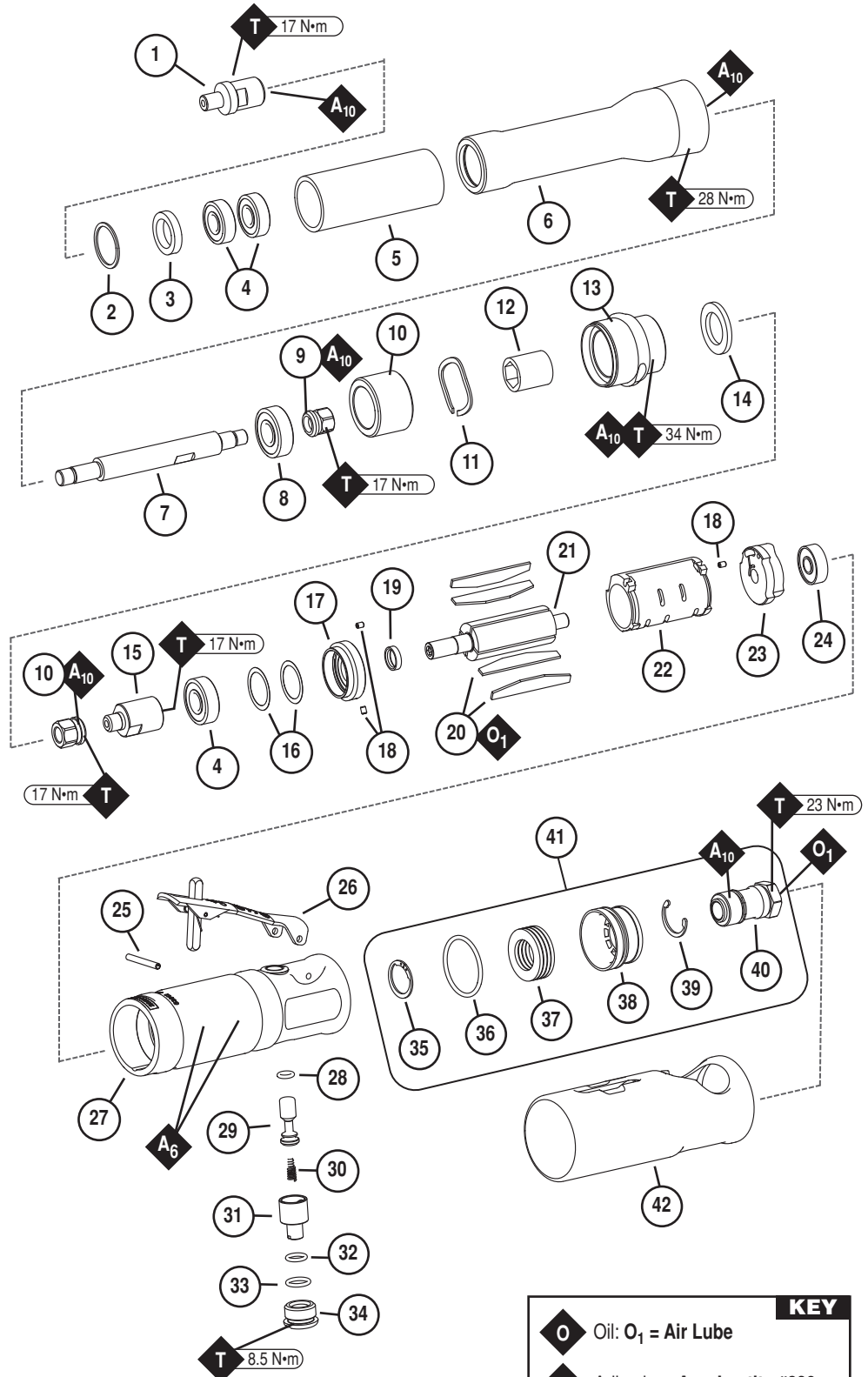

95262 14 mm Wrench

KEY	
O	Oil: O ₁ = Air Lube
A	Adhesive: A ₆ = Loctite #380 A ₁₀ = Loctite #243
T	Torque: N·m x 8.85 = In. - lbs.

Always follow adhesive manufacturers cleaning and priming recommendations.

Disassembly/Assembly Instructions

Important: The Dynabrade Pneumatic Power Tool Lifetime Warranty Policy does NOT cover normally wearable parts and products. Before servicing this tool please contact Dynabrade Inc. or a Dynabrade Subsidiary for information regarding the Dynabrade Pneumatic Power Tool Lifetime Warranty Policy.

Notice: Special repair tooling referred to in these instructions can be ordered from Dynabrade. (See Page 7)

Disconnect tool from the air supply before servicing.

Motor Disassembly:

1. Secure the flats of the motor housing in a vise with aluminum or bronze jaws.
2. Loosen and remove the collet; cap, insert, and any accessory.
3. Use a hot air gun to warm the **02376** Adapter Extension and soften the thread adhesive. Use a 42 mm open end wrench or an adjustable wrench to loosen the adapter extension turning it counterclockwise to remove. Remove the **50902** Coupler, **96498** Spring and **04069** Retaining Plate.
4. Pull the motor assembly from the housing.
5. Fasten the **96346** Bearing Separator (2") around the portion of the **01028** Cylinder that is nearest the **01721** Rear Plate.
6. Position the bearing separator on the table of the **96232** Arbor Press (#2) so that the threaded shaft of the air motor is pointing toward the floor.
7. Use a 1/4" dia. flat end drive punch as a press tool and push the rotor shaft out of the **02649** Bearing. Remove the **01185** Vanes.
8. Use the **96213** Bearing Removal Tool and the **96232** Arbor Press (#2) to remove the **02649** Bearing from the rear plate.
9. Secure the vane portion of the **55021** Rotor in a vise with aluminum or bronze jaws.
10. Use an adjustable wrench or the **95262** Wrench (14 mm) to loosen the collet body turning it counterclockwise.
11. Remove the **02375** Front Plate, **01007** Bearing, Shims, and **01010** Spacer.

Motor Disassembly Complete.

Extension Disassembly:

1. Secure the flats of the **02376** Adapter Extension in a vise with aluminum or bronze jaws so that the extension handle is pointing up.
2. Use a 40mm or an adjustable wrench to remove the handle from the adapter extension turning it counterclockwise.
3. Remove the **51982** Spacer.
4. Use retaining ring pliers to remove the **96524** Retaining Ring and the **51956** Felt Seal.
5. Use a 14 mm open end wrench or an adjustable wrench to secure the **53610** Adapter. Use a 9/16" socket wrench to remove the **51969** Coupling Nut turning it counterclockwise.
6. Use the **96232** Arbor Press (#2) to push the **51955** Spindle with bearings and collet body or adapter out of the handle. Remove the **54520** Bearing from the handle.
7. Use a 12 mm and a 14 mm, or adjustable wrenches to separate the collet body or adapter from the **51955** Spindle turning counterclockwise.
8. Use the **96232** Arbor Press (#2) to remove the two **01007** Bearings from the **51955** Spindle.

Inlet Valve/94535 Muffler Disassembly:

1. Secure the flats of the motor housing in a vise with aluminum or bronze jaws.
2. Use a large flat blade screwdriver or **95900** Split Blade Wrench (sold separately) to remove the **01026** Regulator Plug turning it counterclockwise.
3. Remove all valve components.
4. Use a 2.5 mm drive punch to remove the **01017** Pin and throttle lever.
5. Position the motor housing so that the **94535** Muffler Assembly is pointing up.
6. Use a 17 mm socket wrench to remove the **01578** Inlet Adapter turning it counterclockwise.
7. Remove the **94535** Muffler Assembly.

Inlet Valve/94535 Muffler Disassembly Complete.

Important: Clean and Inspect Parts for Wear or Damage Before Assembling.

Motor Assembly:

1. Secure the vane portion of the **55021** Rotor in a vise with aluminum or bronze jaws.
2. Install the **01010** Spacer onto the rotor.
3. Place .003" (.08 mm) thickness shims into the **02375** Front Plate and install the **01007** Bearing. Slide this assembly onto the rotor.
4. Install the **02377** Adapter onto the rotor. (Torque to 17 N•m/150 in. lbs.)
5. Check the clearance between the rotor and the bearing plate with a .001" (.03 mm) thick feeler gauge. The clearance should be .001" (.03 mm) to .0015" (.04 mm). If it is necessary to adjust the clearance, repeat steps 3-5 adding or removing shims. Once the proper rotor/gap clearance is achieved proceed with the motor assembly.
6. After threaded surfaces have been properly cleaned and primed, apply a small amount of Loctite #243 to the threads of the **02377** Adapter and install the **51969** Coupling Nut onto the adapter. Turn clockwise using a 9/16" socket. (Torque to 17 N•m/150 in. lbs.)
7. Install the **01185** Vanes (4/pkg.) that have been lubricated with the **95842** Dynabrade Air Lube 10W/NR (or equivalent).
8. Place the **01028** Cylinder onto the assembly so that the air inlet passage will line up with the air inlet passage in the **01721** Rear Plate.
9. Use the **96240** Bearing Press Tool to install the **02649** Bearing into the **01721** Rear Plate. Note: Use the **96240** Bearing Press Tool so that it touches against the outer race of the bearing.
10. Use the **96240** Bearing Press Tool and the **96232** Arbor Press (#2) to install the bearing/rear plate assembly onto the **55021** Rotor.
Note: The press tool should push against the inner race of the bearing. **Important:** Carefully press the bearing/rear plate assembly onto the rotor to achieve a snug fit between the bearing plates and the cylinder. A snug fit will trap the cylinder while still allowing it to be shifted from side to side with a slight amount of finger pressure. A loose fit will not achieve proper preload of the motor bearings.

(continued on next page)

Disassembly/Assembly Instructions (Continued)

11. Align the outer diameters of the front plate, cylinder, and rear plate. Carefully slide the motor assembly into the housing. Align the line-up pin in the front plate with the groove on the inside of the motor housing. Make sure that the motor is positioned properly so that it fits all the way into the housing before installing the adapter extension.
12. Secure the flats of the motor housing in a vise with aluminum or bronze jaws so that the rotor shaft is pointing up.
13. Install the **04069** Retaining Plate into the **02376** Adapter Extension. After threaded surfaces have been properly cleaned and primed, apply a small amount of Loctite #567 (or equivalent) to the threads of the adapter extension and install these parts onto the motor housing. (Torque to 34 N•m/300 in. lbs.) Note: Check the motor for proper adjustment. With the motor still mounted in the vise, pull up on the end of the coupling nut while turning it back and forth. (Apply 7-10 lbs. force.) Perform the same procedure while pushing down on the coupling nut with the same amount of force. The rotor should turn freely without any drag or rub. If a pull rub exists, increase preload or remove shims. If a push rub exists, remove some load or add shims.

Motor Assembly Complete.

Extension Assembly:

1. Use the **96232** Arbor Press (#2) and the **96244** Bearing Press Tool to install the two **01007** Bearings onto the **51955** Spindle.
2. After threaded surfaces have been properly cleaned and primed, apply a small amount of Loctite #243 to the outer threads of the spindle.
3. Use a 12 mm open end wrench to hold the **51955** Spindle stationary. Use a 14 mm crowfoot and torque wrench to install the **50011** Collet Body or **53610** Adapter onto the spindle. (Torque to 17 N•m/150 in. lbs.)
4. Install the spindle with bearings into the **51952** Handle.
5. Install the **51956** Felt Seal and the **96524** Retaining Ring to secure the spindle assembly in the handle.
6. Support the collet body or adapter on the table of the arbor press and use the **96244** Bearing Press Tool to install the **54520** Bearing onto the spindle.
7. After threaded surfaces have been properly cleaned and primed, apply a small amount of Loctite #243 to the threads of the spindle and install the **51969** Coupling Nut.
8. Use a 14 mm open end or adjustable wrench to hold the collet body or adapter stationary. Use a 9/16" socket and torque wrench to install the **51969** Coupling Nut on the spindle. (Torque to 17 N•m/150 in. lbs.)
9. Install the **50902** Coupler onto the coupling nut.
10. Secure the flats of the **51952** Handle in a vise with aluminum or bronze jaws so that the work end of the spindle is pointing down. Install the **51982** Spacer into the handle. After threaded surfaces have been properly cleaned and primed, apply a small amount of Loctite #567 to the threads of the handle and install the **02376** Adapter Extension onto the handle. Use a crowfoot and torque wrench to install the adapter extension onto the handle. (Torque to 28 N•m/250 in. lbs.)

Extension Assembly Complete:

Inlet Valve/94535 Muffler Assembly:

1. Secure the flats of the motor housing in a vise with aluminum or bronze jaws so that the air inlet opening is pointing up.
2. Install the **01021** Valve Stem with **01020** O-Ring set into groove and **01022** Spring (insert small diameter end into valve stem hole) into the valve bushing.
3. Install the **01023** Speed Regulator with **01024** O-Ring into the air inlet opening.
4. Install the **01026** Regulator Plug with **95288** O-Ring set into groove (using **95900** Split Blade Wrench, sold separately, torque to 8.5 N•m/75 in. lbs.).
5. Use a flat blade screwdriver to adjust the **01023** Speed Regulator to the open position.
6. Install the throttle lever securing it with the **01017** Pin.
7. Use the exploded view of the **94535** Muffler Assembly for the order of assembly.
8. After threaded surfaces have been properly cleaned and primed, apply a small amount of the Loctite #567 (or equivalent) to the external threads of the **01578** Inlet Adapter and install the **94535** Muffler Assembly. (Torque to 23 N•m/200 in. lbs.)
9. Hold the **01578** Inlet Adapter stationary with an adjustable wrench while installing the air fitting.

Inlet Valve/94535 Muffler Assembly Complete.

Tool Assembly Complete. Please allow 30 minutes for adhesives to cure before operating tool.

Important: Before operating, place 2-3 drops of Dynabrade Air Lube (P/N **95842**) directly into air inlet with throttle lever depressed. Operate tool for 30 seconds to determine if tool is operating properly and to allow lubricating oils to properly penetrate motor. Motor should now be tested for proper operation at 90 PSIG. If motor does not operate properly or operates at a higher RPM than marked on the tool, the tool should be serviced to correct the cause before use.

Loctite® is a registered trademark of Loctite Corp.

Lifetime Warranty

All Dynabrade portable pneumatic power tools are rigorously inspected and performance tested in our factory before shipping to our customers. If a Dynabrade tool develops a performance problem and an inherent defect is found during normal use and service, Dynabrade will warrant this tool against defects in workmanship and materials for the lifetime of the tool. Upon examination and review at our factory, Dynabrade shall confirm that the tool qualifies for warranty status, and will repair or replace the tool at no charge to the customer. Normally wearable parts and products are NOT covered under this warranty. Uncovered items include bearings, contact wheels, rotor blades, regulators, valve stems, levers, shrouds, guards, O-rings, seals, gaskets and other wearable parts. Dynabrade's warranty policy is contingent upon proper use of our tools in accordance with factory recommendations, instructions and safety practices. It shall not apply to equipment that has been subjected to misuse, negligence, accident or tampering in any way so as to affect its normal performance. To activate lifetime warranty, customer must register each tool at www.dynabrade.com. Dynabrade will not honor lifetime warranty on unregistered tools. A one-year warranty will be honored on all unregistered portable pneumatic power tools. Lifetime warranty applies only to portable pneumatic tools manufactured by Dynabrade, Inc. in the USA. Lifetime warranty applies only to the original tool owner; warranty is non-transferable.

Preventative Maintenance Schedule

.7 hp Extension Cone or Plug Grinder – All Models

This service chart is published as a guide to expectant life of component parts. The replacement levels are based on average tool usage over one year. Dynabrade Inc. considers one year usage to be 1,000 hours.

Parts Common to all Models:

Index #	Part Number	Description	Number Required	High Wear 100%	Medium Wear 70%	Low Wear 30%	Non-Wear 10%
1	53610	Adapter	1			X	
2	96524	Retaining Ring	1			X	
3	51956	Felt Seal	1			X	
4	01007	Bearing	3		T (1)		
5	53690	Grip	1			X	
6	51952	Handle	1				X
7	51955	Spindle	1				X
8	54520	Bearing	1			X	
9	51969	Coupling Nut	2			X	
10	51982	Spacer	1				X
11	96498	Spring	1				X
12	50902	Coupler	1			X	
13	02376	Adapter Extension	1				X
14	04069	Retaining Plate	1				X
15	02377	Adapter	1				X
16	01121	Shim (3/Pkg.)	1		T		
17	02375	Front Plate	1			X	
18	50767	Pin	3			T	
19	01010	Spacer	1			T	
20	01185	Vane (4/Pkg.)	1	T			
21	55021	Rotor	1			X	
22	01028	Cylinder	1			X	
23	01721	Rear Plate	1				X
24	02649	Bearing	1		T		
25	01017	Pin	1		T		
26	01089	Safety Lever	1			X	
27	02381	Housing	1				X
28	01020	O-Ring	1		T		
29	01021	Valve Stem	1		T		
30	01022	Spring	1		T		
31	01023	Speed Regulator	1				X
32	01024	O-Ring	1		T		
33	95288	O-Ring	1		T		
34	01026	regulator Plug	1				X
35	95711	Snap Ring	1		T		
36	96065	O-Ring	1		T		
37	01486	Felt Silencer	4	T			
38	01446	Air Deflector	1			X	
39	95620	Retaining Ring	1			T	
40	01578	Inlet Adapter	1				X
41	94535	Muffler Assembly	1			X	
42	02347	Insulation Sleeve	1			X	

LEGEND

T	Included in Tune-Up Kit
X	Type of wear, no other comments apply.
L	Easily lost. Care during assembly/disassembly.
D	Easily damaged during assembly/disassembly.
R	Replace each time tool is disassembled.



**Tune-Up Kit
Part No. 98623**

Note: Please refer to page 4 of tool manual for specific part number.

Notice

All Dynabrade motors use the highest quality parts and metals available and are machined to exacting tolerances. The failure of quality pneumatic motors can most often be traced to an unclean air supply or the lack of lubrication. Air pressure easily forces dirt or water contained in the air supply into motor bearings causing early failure. It often scores the cylinder walls and the rotor blades resulting in limited efficiency and power. Our warranty obligation is contingent upon proper use of our tools and cannot apply to equipment which has been subjected to misuse such as unclean air, wet air or a lack of lubrication during the use of this tool.

Machine Specifications

Model Number	Motor hp (W)	Motor RPM	Sound Level	Maximum Air Flow SCFM (LPM)	Spindle Thread Size	Air Pressure PSIG (Bars)	Weight Pound (kg)	Length Inch (mm)	Height Inch (mm)
53783	.7 (522)	20,000	80 dB(A)	39 (1,000)	3/8"-24	90 (6.2)	3.9 (1.7)	12.7 (322)	1.7 (45)

Additional Specifications: Air Inlet Thread 1/4" NPT • Hose I.D. 3/8" (10 mm)
Sound Level is the pressure measurement according to the method outlined in ISO regulation ISO-15744

Optional Accessories

FIND THE MOST CURRENT OFFERING OF SUPPORT DOCUMENTS AND ACCESSORIES AT WWW.DYNABRADE.COM



Dynabrade Air Lube

- Formulated for pneumatic equipment.
- Absorbs up to 10% of its weight in water.
- Prevents rust and formation of sludge.
- Keeps pneumatic tools operating longer with greater power and less down time.

Part No. 95821: 4oz. (118 ml)

Part No. 95842: 1pt. (473 ml)

Part No. 95843: 1gal. (3.8 L)



Split Blade Wrench

- Used to loosen or tighten regulator plug.
- Tool has a 1/4" square socket for use with 1/4" drive; breaker bar, ratchet head, or torque wrenches.

Part No. 95900



Press tools

- Used to install bearings.

Part No. 96241

Part No. 96240



Bearing Separator

- Use the separator to remove gears and bearings.

Part No. 96346



Spindle Adapter

- Converts standard spindle to accept 5/8 -11 Cone or Plugs.

Part No. 53652



Motor Tune-Up Kit

- Includes assorted parts to help maintain and repair motor.

Part No. 98623



Drop-In Motor

- Allows quick and easy replacement.
- No motor adjustments needed.

Part No. 02400 – Model 53783



Composite-Style Coupler

- Lightweight 1.4 oz. (.05 Kg), non-marring composite material.
- Easy connect/disconnect by single push-button action.
- Shock-proof, low-vibration, crush-resistant.

Part No. 94960 – 1/4" Female NPT

Part No. 94980 – 1/4" Male NPT



Male Plug

- Provides up to twice the air flow compared to standard plug design.
- Plug has "ported" design to prevent "starving" of the air tool.

Part No. 95675

Reference Contact Information

1. **American National Standards Institute – ANSI**
25 West 43rd Street
Forth Floor
New York, NY 10036
Tel: 1 (212) 642-4900
Fax: 1 (212) 398-0023

2. **Government Printing Office – GPS**
Superintendent of Documents
Attn. New Orders
P.O. Box 371954
Pittsburgh, PA 15250-7954
Tel: 1 (202) 512-1803

3. **European Committee for Standardization**
Rue de Stassart 36
B - 1050 Brussels, Belgium

Visit Our Web Site: www.dynabrade.com

Email: Customer.Service@Dynabrade.com



DYNABRADE, INC., 8989 Sheridan Drive • Clarence, NY 14031-1490 • Phone: (716) 631-0100 • Fax: 716-631-2073 • International Fax: 716-631-2524
DYNABRADE EUROPE S.à.r.l., Zone Artisanale • L-5485 Wormeldange—Haut, Luxembourg • Telephone: 352 76 84 94 1 • Fax: 352 76 84 95 1

© DYNABRADE, INC., 2009

PRINTED IN USA